

1860
Megohmmeter
Instruction Manual
Form 150794/A1

©QuadTech, Inc., 2005
5 Clock Tower Place, 210 East
Maynard, Massachusetts, U.S.A. 01754
June 2005

Telephone	978-461-2100
Sales	800-253-1230
Facsimile	978-461-4295
Website	www.quadtech.com

The material in this manual is for informational purposes only and is subject to change, without notice. QuadTech assumes no responsibility for any error or for consequential damages that may result from the misinterpretation of any procedures in this publication.

WARNING

Potentially dangerous voltages may be present on front and rear panel terminals. Follow all warnings in this manual when operating or servicing this instrument. Dangerous levels of energy may be stored in capacitive devices tested by this unit. Always make sure the high voltage indicator is **OFF** when connecting or disconnecting the device under test.



Product will be marked with this symbol (ISO#3864) when it is necessary for the user to refer to the instruction manual in order to prevent injury or equipment damage.



Product marked with this symbol (IEC417) indicates presence of direct current.



Product will be marked with this symbol (ISO#3864) when voltages in excess of 1000V are present.

Contents

Warranty	5
Specifications	7
Accessories	9
Safety Precautions	11
Condensed Operating Instructions	13

Introduction - Section 1

1.1	Unpacking and Inspection	15
1.2	Product Overview	15
1.3	Controls and Indicators	16
1.3.1	Front Panel Controls and Indicators	16
1.3.2	Rear Panel Controls and Connectors	18
1.4	Installation	19
1.4.1	Dimensions	19
1.4.2	Instrument Positioning	20
1.4.3	Power Requirements	20
1.4.4	Safety Inspection	21

Operation - Section 2

2.1	Terms and Conventions	23
2.2	Start-Up	25
2.3	Voltage	25
2.4	Range	26
2.5	Select	27
2.5.1	C. SET	28
2.5.2	M. SET	29
2.5.3	COMP	29
2.5.4	BUZZ	30
2.6	Discharge	31
2.7	Connection To Device Under Test	32
2.8	Measurement Procedure	34
2.9	Front Panel Lock	34

Interface - Section 3

3.1	Remote	35
3.1.1	COMP OUT	35
3.1.2	REMOTE IN	36
3.1.3	DC OUT	38
3.2	RS232 Interface	39
3.2.1	PIN Configuration	39
3.2.2	RS232 Specifications	39
3.2.3	RS232 Commands	40
3.2.4	RS232 Printer Output	41
3.3	HV ENABLE	41
3.4	Surface Plate Sample Test Fixture	42

Service & Calibration - Section 4

4.1	General	43
4.2	Instrument Return	43
4.3	Calibration	43

Warranty



QuadTech warrants that Products are free from defects in material and workmanship and, when properly used, will perform in accordance with QuadTech's applicable published specifications. If within one (1) year after original shipment it is found not to meet this standard, it will be repaired, or at the option of QuadTech, replaced at no charge when returned to a QuadTech service facility.

Changes in the Product not approved by QuadTech shall void this warranty.

QuadTech shall not be liable for any indirect, special or consequential damages, even if notice has been given of the possibility of such damages.

This warranty is in lieu of all other warranties, expressed or implied, including, but not limited to any implied warranty or merchantability or fitness for a particular purpose.

SERVICE POLICY

QuadTech's service policy is to maintain product repair capability for a period of at least five (5) years after original shipment and to make this capability available at the then prevailing schedule of charges.

Specifications

Resistance Range: 250kΩ – 20TΩ

Voltage	Low Range	High Range	Full Range	Accuracy
50	2.5×10^5	1×10^{12}	250kΩ – 1TΩ	±10%
100	5×10^5	2×10^{12}	500kΩ – 2TΩ	±10%
250	1.25×10^6	5×10^{12}	1.25MΩ – 5TΩ	±10%
500	2.5×10^6	1×10^{13}	2.5MΩ – 10TΩ	±10%
1000	5×10^6	2×10^{13}	5MΩ – 20TΩ	±10%

Test Voltage: 50, 100, 250, 500 or 1000V DC
±(3% of set value)

Output Current: 2mA Maximum

Test Time: Charge Time: 000 to 999sec
Measure Time: 000 to 999sec

Sampling Cycle: 60milliseconds measuring time

Charge Function: 30kΩ internal resistance

Discharge Function: 100kΩ internal resistance

Interlock: HV-EN (High Voltage Enable), rear panel connector

Connectors: Rx+, Rx-: Sheathed Banana Plug Terminals

Limits: Set a Comparison value (Low Limit) for Resistance Test
Judgement Function displays NO/GO for measured resistance value

Indication: NO/GO Display, audible sound, HV indicator

Display: 320x240 LCD, Text and Bargraph

Buzzer Level: ON, OFF

Setup Storage: Power-Down condition

Remote Control: Inputs: START, STOP
Outputs: GO, NO, DC OUT (OPTION)
Characteristics: Dry contact relay, 50V max, 50mA max
Connector: 10 screw Terminal Strip

Interfaces: RS-232C, DB9 male

Specifications (Continued)

HV Lockout: Switch: No HV output until Black Lead is inserted in Rx + terminal
Front Panel Display “LOCK”

Mechanical: Bench Mount, Front Flip Feet, Portable
Dimension measurement includes feet and front/rear connectors
Dimensions:(w x h x d):11.125 x 6.0 x 9.0 inches
(282.575 x 152.4 x 228.6 mm)

Weight: 9.5 lbs (4.3kg) net, __ lbs (__ kg) shipping

Environmental: Operating: 0°C to + 40°C
Storage: -5°C to + 70°C
Humidity: <85%
Warm-up Time: 30 minutes

Power:

<ul style="list-style-type: none"> • 100/120/220V AC, ±10% • 50/60Hz 	<ul style="list-style-type: none"> • 240V +10V AC, ±10% • 25W
----------------------------------------------------------------------------------------------	---------------------------------------------------------------------------------------

Supplied:

<ul style="list-style-type: none"> • Instruction Manual • Calibration Certificate 	<ul style="list-style-type: none"> • AC Power Cable • Test Leads (2)
-----------------------------------------------------------------------------------------------------------	----------------------------------------------------------------------------------------------

Ordering Information:

<u>Description</u>	<u>Catalog No.</u>
1860 Megohmmeter	1860

Accessories

Accessories Included

Item	Quantity	QuadTech P/N
AC Power Cord	1	4200-0300
Power Line Fuse 0.4A 250V	1	5330-0900-00
Power Line Fuse 0.2A 250V	1	5330-0600-00
High Voltage Lead Set, 1m, Banana to Alligator Clip	1	1860-01
HV Interlock Plug	1	1860-04
Instruction Manual	1	150794
Calibration Certificate	1	N/A

Accessories/Options Available

Item	Quantity	QuadTech P/N
High Voltage Lead Set, 1m, Banana to Alligator Clip	1	1860-01
Surface Plate Sample Test Fixture	1	1860-02
RS-232 Cable		

Safety Precautions

WARNING

The 1860 Megohmmeter can provide an output voltage as high as 1000V DC to the device under test.

Although each unit is designed with full attention to operator safety, serious hazards could occur if the instrument is used improperly and these safety instructions are not followed.

1. The 1860 Megohmmeter is designed to be operated with its chassis connected to earth ground. The instrument is shipped with a three-prong power cord to provide this connection to ground. Plug this power cord should into a receptacle that provides earth ground. Serious injury can result if the 1860 Megohmmeter is not connected to earth ground.
2. Tightly connect cable(s) to the Rx- terminal. If this is not done, the DUT's casing can be charged to the high voltage test level and serious injury or electrical shock hazards could result if the DUT is touched.
3. Never touch the metal of the High Voltage probe directly. Touch only the insulated parts of the lead(s).
4. Never touch the test leads, test fixture or DUT in any manner (this includes insulation on all wires and clips) when the high voltage is applied and the red **V.OUT** light is ON.
5. Before turning on the 1860 Megohmmeter, make sure there is no device (DUT) or fixture connected to the test leads.
6. When the red **V.OUT** LED is ON or flashing, NEVER touch the device under test, the lead wires or the output terminals.
7. Before touching the test lead wires or output terminals make sure:
 - a) The green [**MEASURE/DISCHARGE**] button has been pressed.
 - b) The red **V.OUT** LED is OFF.
8. In the case of an emergency, turn OFF the [POWER] switch using a "hot stick" and disconnect the AC power cord from the wall. DO NOT TOUCH THE Guardian INSTRUMENT.
9. If the **V.OUT** LED does not go OFF when the [**MEASURE/DISCHARGE**] button is pressed, immediately stop using the tester. It is possible that the output voltage is still being delivered regardless of the TEST ON/OFF control signal.
10. Be extremely careful when the 1860 instrument is used in remote control mode. The High Voltage Output is being turned on and off with an external signal.

Condensed Operating Instructions

WARNING

High Voltage is applied to the red Rx- output terminal anytime the red **V.OUT** LED is lit or flashing. Always make sure the **V.OUT** LED is OFF when connecting or disconnecting the Device Under Test (DUT).

General Information

The 1860 Megohmmeter outputs test voltage of 50, 100, 250, 500 and 1000VDC. The output current is limited to 2mA. The 1860 Megohmmeter measures insulation resistance from 250k Ω to 20T Ω dependent on the voltage range selected. In addition to the measured value, a NO/GO display provides a visual indication of the test result based on a preset comparison limit.

Start-Up

The 1860 Megohmmeter can be operated from a power source between 90 and 250VAC at a power line frequency of 50 or 60Hz. The 1860 unit is shipped from QuadTech with a 0.4A fuse in place for AC 90-130V operation. (A 0.2A fuse is included for 200-250V operation). The 1860 instrument is shipped with the line voltage selector set for 120V. Refer to paragraph 1.4.3 to change a fuse and to change the line voltage selector.

Connect the 1860 Megohmmeter AC power cord to the source of proper voltage. The 1860 instrument is designed to be operated with its chassis connected to earth ground. Each 1860 unit is shipped with a three prong power cord to provide this connection to ground. This power cord should only be plugged in to a receptacle which provides earth ground. Serious injury can result if the 1860 instrument is not connected to earth ground.

Press the [POWER] button on the front panel to apply power. To switch the power off press the [POWER] button again or if measurements are to be made proceed with Test Parameter Set-Up below. Note: the 1860 instrument should warm-up for a minimum of 30 minutes prior to use.

Test Parameter Set-Up

Test Voltage: VOLTAGE: 50/100/250/500/1000V
Measurement Range: RANGE: x1/x10/x10²/x10³/x10⁴/x10⁵

Press [SELECT] and enter the Test Parameters using [UP] and [DOWN] buttons.

Charge Time: [C.SET]: 000 – 999 seconds
Measure Time: [M.SET]: 000 – 999 seconds
Comparison: [COMP]: 000 – 10x Value of selected resistance range
Buzzer: [BUZZ]: On/OFF to sound for failure result of Comparison

Condensed Operating Instructions

Measurement Mode

The 1860 Megohmmeter measures Insulation Resistance. Refer to paragraph 2.7 for the appropriate cable connection to the device under test. Refer to paragraphs 2.3 - 2.5 for instruction on programming a test parameter for the Insulation Resistance test.

Insulation Resistance Measurement Example:

- 1 Turn Power ON.
- 2 Allow 1860 unit to warm-up for 30 minutes.
- 3 Connect Black ground cable to Rx+ terminal.
- 4 Connect Red high voltage cable to Rx- terminal.
- 5 Press [SELECT] and enter your Test Parameters.
- 6 Turn [VOLTAGE] knob to test voltage.
- 7 Turn [RANGE] knob to lowest multiplier.
- 8 Connect Device Under Test (DUT).
- 9 Press green [CHARGE] button.
- 10 Press green [MEASURE/DISCHARGE] button.
- 11 Record Readings.
- 12 Press red [SELECT] button or [MEASURE/DISCHARGE] at any time during measurement to STOP measurement and terminate HV at output terminals.

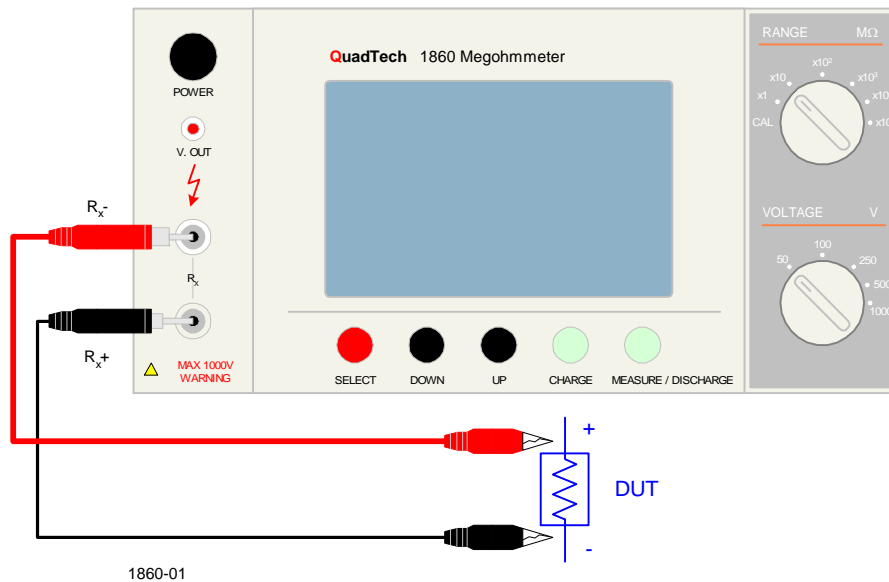

Figure COI-1: 1860-01 Cable Connection To Device Under Test

Section 1 : Introduction

1.1 Unpacking and Inspection

Inspect the shipping carton before opening. If damaged contact the carrier agent immediately. Inspect the 1860 instrument for any damage. If the instrument appears damaged or fails to meet specifications notify QuadTech (refer to instruction manual front cover) or its local representative. Retain the shipping carton and packing material for future use such as returning for recalibration or service.

1.2 Product Overview

The 1860 Megohmmeter is a general purpose high voltage instrument for resistance measurements on insulating materials and components. The 1860 provides a direct readout of resistance from 250k Ω to 20T Ω at five programmable DC test voltages between 50 and 1000V. Current output is limited to 2mA. Charge Time and Measure Time are fully programmable from 000 – 999 seconds in 1 second steps.

The 1860 Megohmmeter includes a 320x240 graphic LCD display with text and bargraph results of the measured value, test voltage and test time. The measured value can also be displayed with a NO/GO indication, based on the judgment limit set in the Comparison function. Safety features include the 2mA current limiting function, the front panel HV warning indicator and the HV-EN interlock function on the rear panel. The 1860 instrument comes standard with a Remote I/O Terminal Strip and an RS-232C interface. The instrument comes standard with the 1860-01 HV Lead Set and optional accessories include the 1860-02 Surface Plate Sample Test Fixture.

WARNING: HIGH VOLTAGE

The 1860 Megohmmeter is capable of generating up to 1000VDC.
Do NOT touch the Test Terminals when the red **V.OUT** LED is ON.
Always make sure the **V.OUT** LED is OFF when connecting or disconnecting the device under test (DUT)

1.3 Controls and Indicators

1.3.1 Front Panel Controls and Indicators

Figure 1-1 illustrates the controls and indicators on the front panel of the 1860 Megohmmeter. Table 1-1 identifies the controls and indicators with descriptions and functions. Figure 1-2 is a detailed illustration of the display (8 of Figure 1-1).

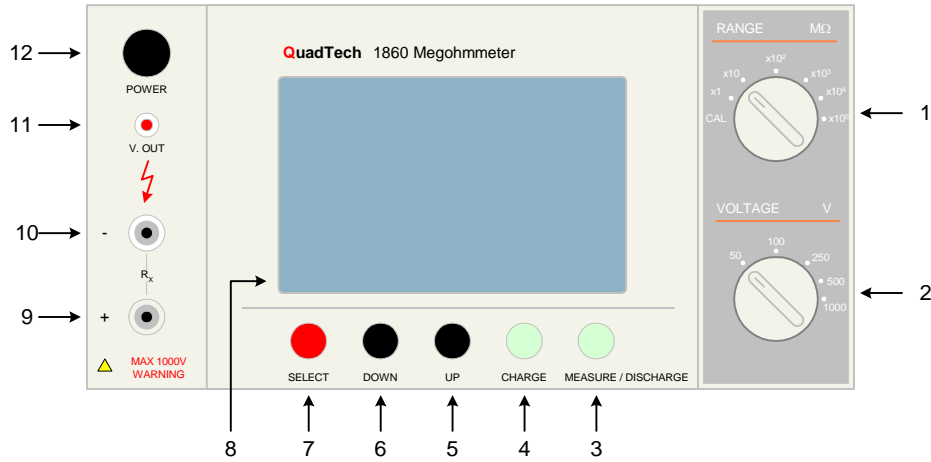

Figure 1-1: Front Panel Controls & Indicators

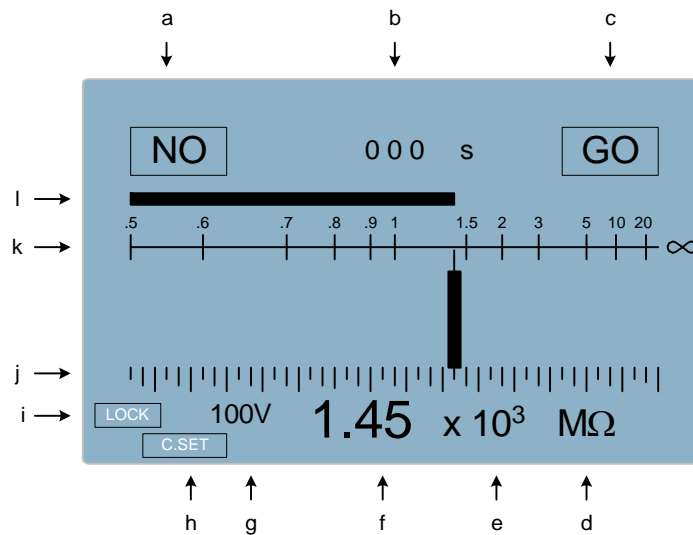

Figure 1-2: Close-Up of Display

Table 1-1 : 1860 Front Panel Controls and Indicators

Reference Number Figures 1-1 and 1-2	Name	Type	Function
1	RANGE	Grey Rotary Switch	Select Resistance Range: x1/x10/x10 ² /x10 ³ /x10 ⁴ /x10 ⁵
2	VOLTAGE	Grey Rotary Button	Select Test Voltage: 50/100/250/500/1000V
3	MEASURE DISCHARGE	Green Push Button	Apply test voltage to DUT for programmed M.SET
4	CHARGE	Green Push Button	Apply test voltage to DUT for programmed C.SET
5	UP	Black Push Button	Increase value of Selected Function
6	DOWN	Black Push Button	Decrease value of Selected Function
7	SELECT	Red Push Button	To program test function: C.SET, M.SET, COMP, LOCK
8	Display	320x240 LCD	Indicates range, voltage, time, limit, test result
8a	NO	2 digits	When backlit, indicates Measured Value is a FAIL
8b	Timer	3 digits, Count Down	Elapsed Time during test: 999 to 000 seconds
8c	GO	2 digits	When backlit, indicates Measured Value is a PASS
8d	MΩ	2 digits	Unit of Measured Resistance
8e	x10 ^x	4 digits	Resistance Range Multiplier
8f	Value	3 digits	Measured Resistance
8g	Voltage	3 digits	Test Voltage applied to device under test
8h	C.SET, M.SET, COMP, BUZZ	4 digits	C.SET: Set Charge Time: 000 – 999 seconds M.SET: Set Measure Time: 000 – 999 seconds COMP: Set Comparison Value (Low Limit for IR Test) BUZZ: Set Buzzer ON or OFF (for Comparison Fail)
8i	LOCK	4 digits	When backlit, indicates INTERLOCK is ON
8j	Graph	Line Graph	Analog indicator of Measured Value
8k	Log	Logarithmic Scale	Analog Resistance Scale based on set Test Voltage
8l	Graph	Bar Graph	Visual indication of Measured Value
9	RX+	Black Banana Plug Rec.	Ground Reference for ALL Tests
10	RX-	Red Banana Plug Rec.	High Voltage Output Terminal
11	V.OUT	Red LED	When lit, High Voltage is output at test terminals
12	POWER	Black Push Button	Applies AC power to unit, 0=OFF, 1=ON

1.3.2 Rear Panel Controls and Indicators

Figure 1-3 illustrates the controls and indicators on the rear panel of the 1860 Megohmmeter. Figure 1-4 is a detailed illustration of the remote connectors on the rear panel of the 1860 instrument. Table 1-2 identifies them with description and function.

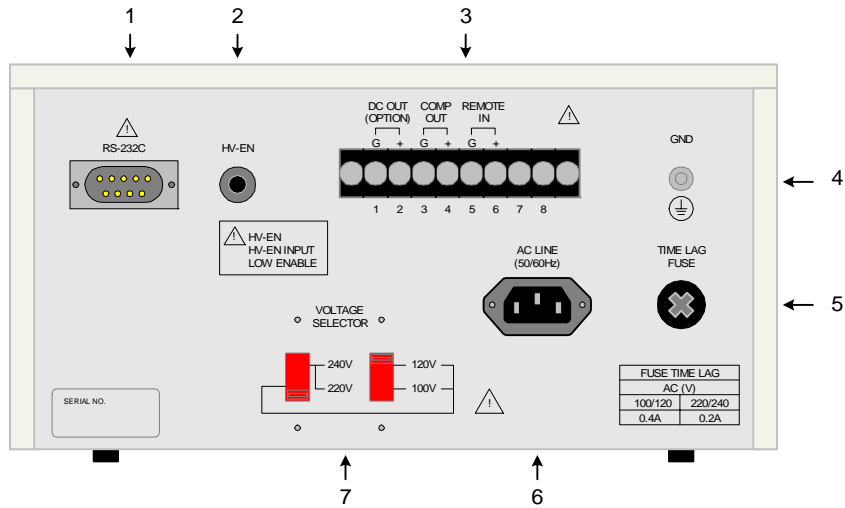

Figure 1-3: Rear Panel Controls and Indicators

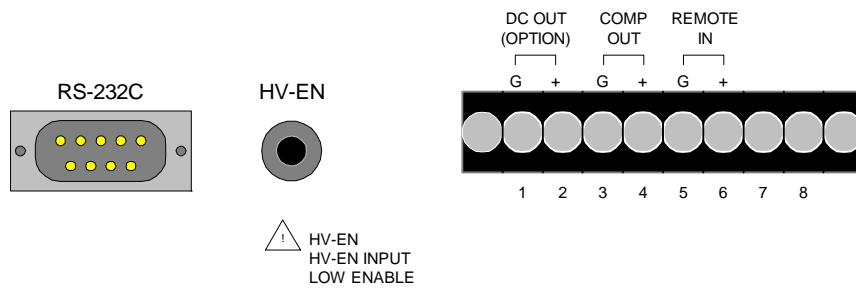

Figure 1-4: Close-Up Remote Connectors

Table 1-2: 1860 Rear Panel Connectors and Controls

Reference Number Fig 1-3,1-4	Name	Type	Function
1	RS-232C	Silver, DB9-pin, Male	RS232 Interface Connection
2	HV-EN	Silver Banana Plug Rec.	Enable rear panel HV output or use Safety Interlock Plug to disable rear panel HV output
3	Terminal	Black 10 screw relay strip (Refer to Figure 1-4)	Input signals : REMOTE Output signal : COMP; DC OUT
4	GND	Silver Banana Plug Screw	Chassis Ground Connection
5	FUSE	Black Screw Cap Fuse	Power Line Fuse 0.4A 250V 100-120V operation 0.2A 250V 220-240V operation
6	AC LINE	Black 3-prong receptacle (Refer to Figure 1-4, 1-6)	3-wire connection for AC Power Source.
7	VOLTAGE SELECTOR	Red 2-position Slide Switches (2) (Refer to Figure 1-6)	Switches for selecting range of AC power source: Set to 100V for 90-100VAC operation Set to 120V for 110-130VAC operation Set to 220V for 200-220VAC operation Set to 240V for 220-250 VAC operation

1.4 Installation

1.4.1 Dimensions

The 1860 instrument is supplied in bench configuration (a cabinet with resilient feet for placement on a table). Flip feet are provided under the front feet so that the unit can be tilted back for convenient operator viewing.

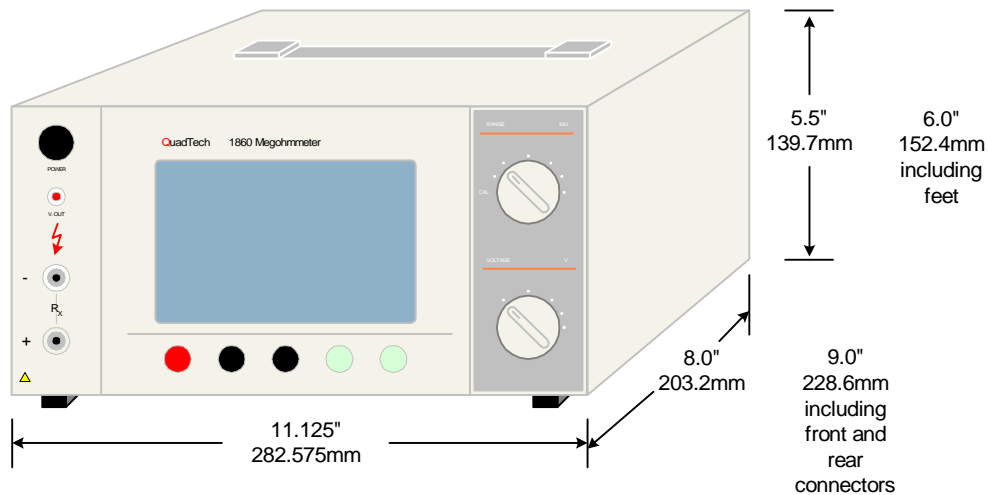



Figure 1-5 : 1860 Instrument Dimensions

1.4.2 Instrument Positioning

The 1860 instrument contains a 320 x 240 LCD display for direct readout of the measured parameters. The optimum viewing angle is slightly down and about 10° either side of center. For bench operation the front flip feet should always be used to angle the instrument up. In bench or rack mount applications the instrument should be positioned with consideration for ample air flow around the rear panel fan ventilation hole. An open space of at least 3 inches (75mm) is recommended behind the rear panel.

1.4.3 Power Requirements

 The 1860 instrument can be operated from a power source of 90 to 130 VAC or 200 to 250 VAC. Power connection is via the rear panel through a standard receptacle. Before connecting the 3-wire power cord between the unit and AC power source make sure the voltage selection switches on the rear panel and fuse (Figure 1-6) are in accordance with the power source being used. The 1860 unit requires a 0.4A 250V fuse for 120V operation (0.2A 250V fuse for 220V operation) with a max power rating of 600W. Always use an outlet that has a properly connected protection ground.

Procedure for Changing An 1860 Megohmmeter Fuse

WARNING
MAKE SURE THE UNIT HAS BEEN DISCONNECTED FROM ITS AC POWER SOURCE FOR AT LEAST 5 MINUTES BEFORE PROCEEDING.

Remove the screw cap fuse drawer, by inserting a 4mm phillips head screwdriver into the TIME LAG FUSE cover, and turn the cap counter-clockwise.

Remove the cover from the instrument, pull out the old fuse from the holder and replace with new fuse. Make sure the new fuse is of the proper rating. Install the fuse cap back into the instrument and using a 4mm phillips head screwdriver turn the TIME LAG FUSE cover clockwise until it is securely in place.

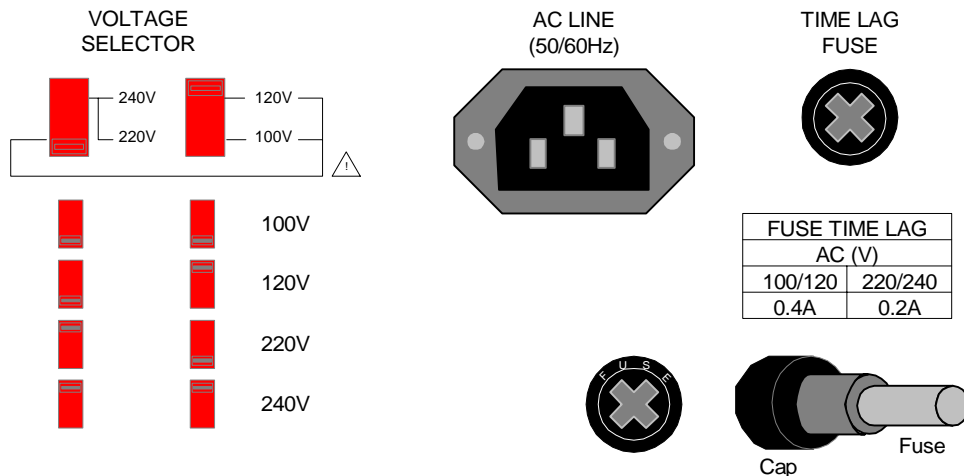

Figure 1-6 : 1860 Megohmmeter Voltage Selector & Fuse Drawer

1.4.4 Safety Inspection



Before operating the instrument inspect the power inlet module on the rear of the Guardian unit to ensure that **the properly rated fuse is in place**, otherwise damage to the unit is possible. Refer to paragraph 1.4.3.

The 1860 unit is shipped from QuadTech with a standard U.S. power cord, QuadTech P/N 4200-0300 (with Belden SPH-386 socket or equivalent and 3-wire plug conforming to IEC 320). Make sure that the instrument is used only with these cables (or approved international cord set) to ensure that the instrument is provided with **connection to protective earth ground**.

The surrounding environment should be free from excessive dust to prevent contamination of electronic circuits. The surrounding environment should also be free from excessive vibration. Do not expose the 1860 instrument to direct sunlight, extreme temperature or humidity variations, or corrosive chemicals.

Section 2 : Operation

2.1 Terms and Conventions

Table 2-1: Measurement Unit Prefixes

<u>Multiple</u>	<u>Scientific</u>	<u>Engineering</u>	<u>Symbol</u>
1000000000000000	10 ¹⁵	Peta	P
1000000000000	10 ¹²	Tera	T
1000000000	10 ⁹	Giga	G
1000000	10 ⁶	Mega	M
1000	10 ³	Kilo	k
.001	10 ⁻³	milli	m
.000001	10 ⁻⁶	micro	μ
.000000001	10 ⁻⁹	nano	n
.000000000001	10 ⁻¹²	pico	p
.000000000000001	10 ⁻¹⁵	femto	f

ARCing: Sparking or ‘flashing over’ caused by a breakdown of electrical insulation.

Current:

AC: Alternating Current. An electric current that has one polarity during part of the cycle and the opposing polarity during the other part of the cycle. Residential electricity is AC.

DC: Direct Current. Non-reversing polarity. The movement of charge is in one direction. Used to describe both current and voltage. Batteries supply direct current (DC).

Charging Current: An insulated product exhibits the basic characteristics of a capacitor. Application of a voltage across the insulation causes a current to flow as the capacitor charges. This current instantaneously rises to a high value as voltage is applied then exponentially decays to zero as the DUT becomes fully charged. Charging current decays to zero much faster than dielectric absorption.

Dielectric Absorption: The physical phenomenon in which insulation appears to absorb and retain an electrical charge slowly over time. Apply a voltage to a capacitor for an extended period of time, then quickly discharge it to zero voltage. Leave the capacitor open circuited for a period of time then connect a voltmeter to it and measure the residual voltage. The residual voltage is caused by the dielectric absorption of the capacitor.

Dielectric Strength: The ratio between the voltage at which breakdown of the insulating material occurs and the distance between the two points subject to the applied voltage.

Discharge: The act of draining off an electrical charge to ground. Devices that retain charge should be discharged after an IR or DC HiPot test.

DUT: Device Under Test. The product being tested.

Ground: The base reference from which voltages are measured, nominally the same potential as the earth. Also the side of a circuit that is at the same potential as the base reference.

Insulation Resistance: Measures the total resistance between any two points separated by electrical insulation. The IR test determines how effective the dielectric (insulation) is in resisting the flow of electrical current.

Interface:

RS232: An industry standard definition for a Serial line communication link or port.

Limits:

High Limit: The high limit is the upper value for a test to be considered a pass. If the measured value is higher than the high limit the test is considered a fail.

Low Limit: The low limit is the lower value for a test to be considered a pass.

Time:

Charge: The period of time for the voltage to settle at the programmed level.

Measure: The period of time for the voltage to be applied to the DUT.

Discharge: The period of time for the voltage to be discharged to 0 volts.

2.2 Startup

Check to make sure the Red Voltage Selector Switches on the rear panel agree with the power source available. Depending on the power source the switch positions should be in the up or down positions as shown in Figure 1-6 (Voltage Selector & Fuse Drawer).

WARNING

NEVER TOUCH THE TEST LEADS IN ANY MANNER (this includes insulation on all wires and clips) when the HIGH VOLTAGE IS APPLIED and red **V.OUT** LED is ON.

USE ALL PRECAUTIONS NECESSARY TO AVOID TOUCHING THE DEVICE UNDER TEST WHEN THE RED **V.OUT** LED IS ON OR FLASHING.

Connect the instrument power cord to the source of proper voltage. **The instrument is to be used only with three wire grounded outlets.**

Power is applied to the 1860 instrument by pressing the black [POWER] push-button switch on the front panel to ON (in position). The 1860 unit should have a warm-up time of at least 30 minutes prior to use.

WARNING

DO NOT TURN INSTRUMENT POWER ON OR OFF WITH TEST DEVICES CONNECTED.

2.3 VOLTAGE

Use the [VOLTAGE] rotary switch to select the test voltage to be applied to the device under test. Select 50V, 100V, 250V, 500V or 1000V DC. Recall from the Specifications page, the measurement range is dependent on the test voltage.

Table 2-1: Test Voltage & Resistance Range

Resistance Range: 250k Ω – 20T Ω

Voltage	Low Range	High Range	Full Range	Accuracy
50	2.5 x 10 ⁵	1 x 10 ¹²	250k Ω – 1T Ω	±10%
100	5 x 10 ⁵	2 x 10 ¹²	500k Ω – 2T Ω	±10%
250	1.25 x 10 ⁶	5 x 10 ¹²	1.25M Ω – 5T Ω	±10%
500	2.5 x 10 ⁶	1 x 10 ¹³	2.5M Ω – 10T Ω	±10%
1000	5 x 10 ⁶	2 x 10 ¹³	5M Ω – 20T Ω	±10%

NOTE:

Test Voltage will not be applied until the Test Leads are fully inserted in the Rx- and Rx+ terminals and the [MEASURE] switch is pressed.

When the [VOLTAGE] switch is changed, the logarithmic scale on the display changes and the test voltage is shown in the lower left-hand corner of the display. Refer to Figure 2-1.

VOLTAGE:

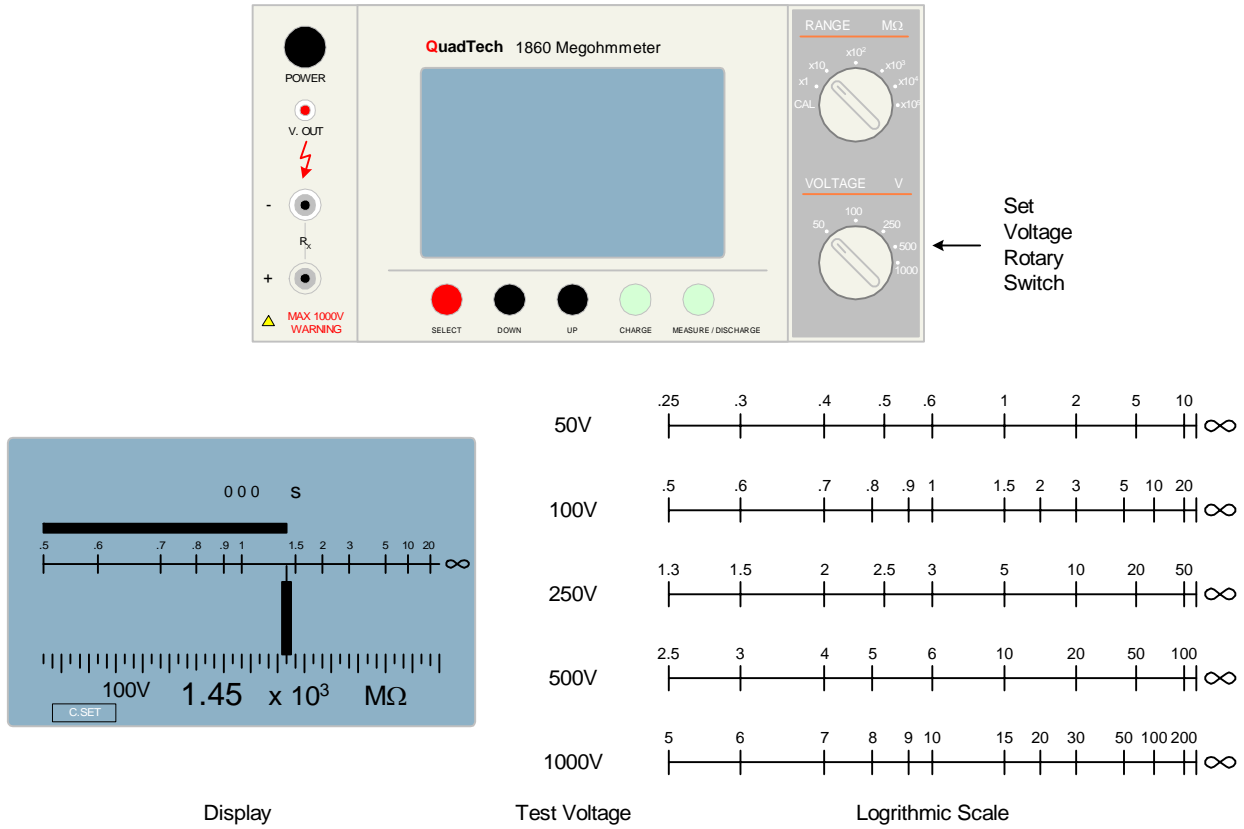

Figure 2-1: Set VOLTAGE

2.4 RANGE

Use the [RANGE] rotary switch to select the measurement range for the device under test (DUT). Set the [RANGE] switch to the expected range of the DUT. If uncertain of the DUT's value, set the [RANGE] switch to the lowest (x1) range. The [RANGE] switch selects the factor (multiplier) for the measured value.

Table 2-2: Multiplier and Measured Value

Multiplier	Range
x1	Measured Value
x10	Measured Value x 10
x10 ²	Measured Value x 100
x10 ³	Measured Value x 1000
x10 ⁴	Measured Value x 10,000
x10 ⁵	Measured Value x 100,000

Example: If the DUT value is 500kΩ, set [RANGE] to the [x10¹] position. Set the [VOLTAGE] to 50V. Press [CHARGE] and then [MEASURE]. The display should read: .500 x 10⁰ MΩ.

RANGE:

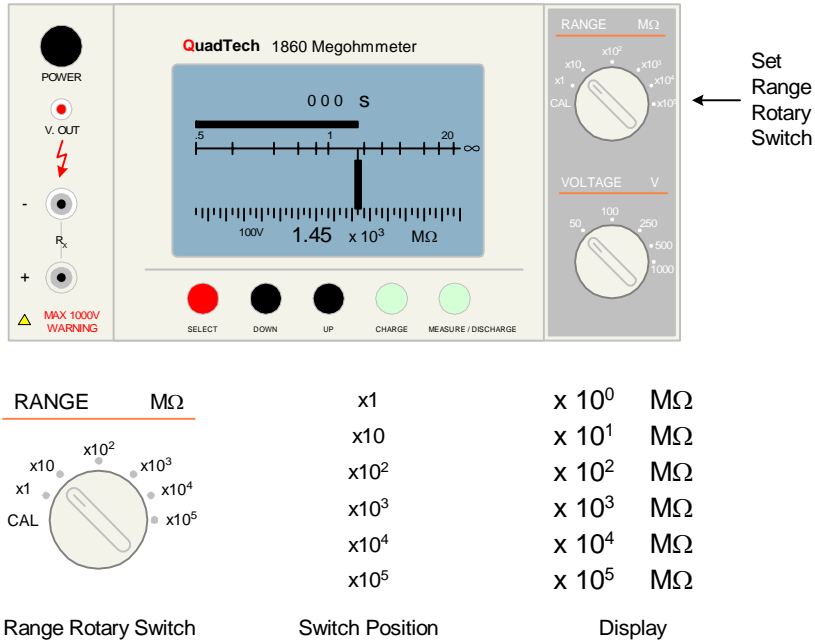

Figure 2-2: Set RANGE

2.5 SELECT

Press the [SELECT] button to set these test functions: C.SET (Charge Time), M.SET (Measure Time), COMP (Comparison/Limit Set) and BUZZ (Audible Buzzer). In the lower left-hand corner, the display will show the current function within a backlit box: **C.SET**. Press [SELECT] again to go to next parameter or press [UP] or [DOWN] to program the selected (backlit) parameter.

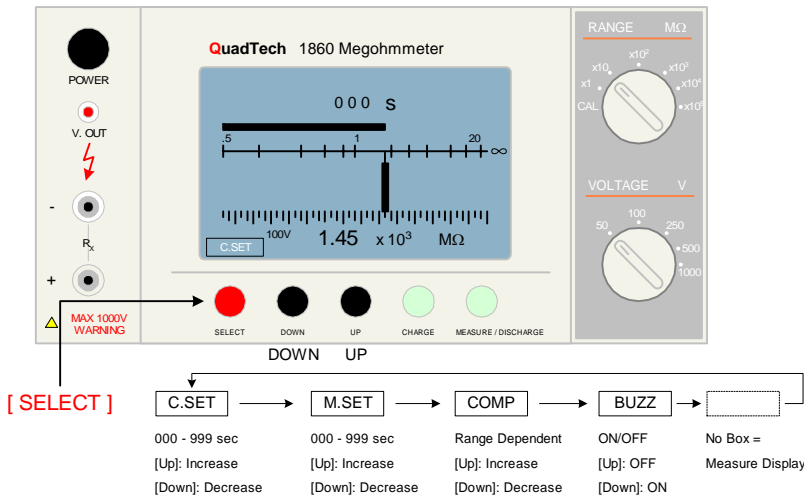

Figure 2-3: SELECT

2.5.1 C.SET

A charge time allows the device under test to be ramped (charged) up to the test voltage. Charge time can be set from 1 to 999 seconds. To set a CHARGE TIME to be applied to the DUT, press the [SELECT] button and make sure the test function **C.SET** is in the backlit box in the lower left-hand corner. Press the [UP] button to increase charge time or the [DOWN] button to decrease the charge time. Press [SELECT] again to exit and return to the measure display.

If a charge time is set, when [CHARGE] is pressed, the **V. OUT** LED lights and the 1860 instrument applies the test voltage to the test terminals for the programmed time. At the end of the charge time, the 1860 automatically measures the DUT.

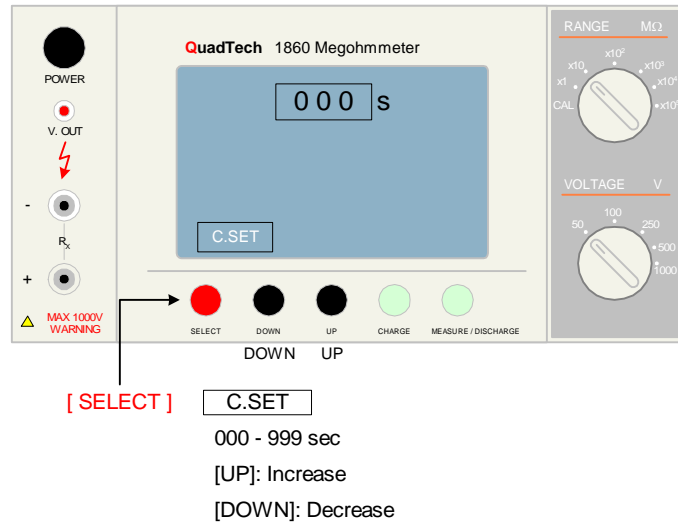

Figure 2-4: C.SET

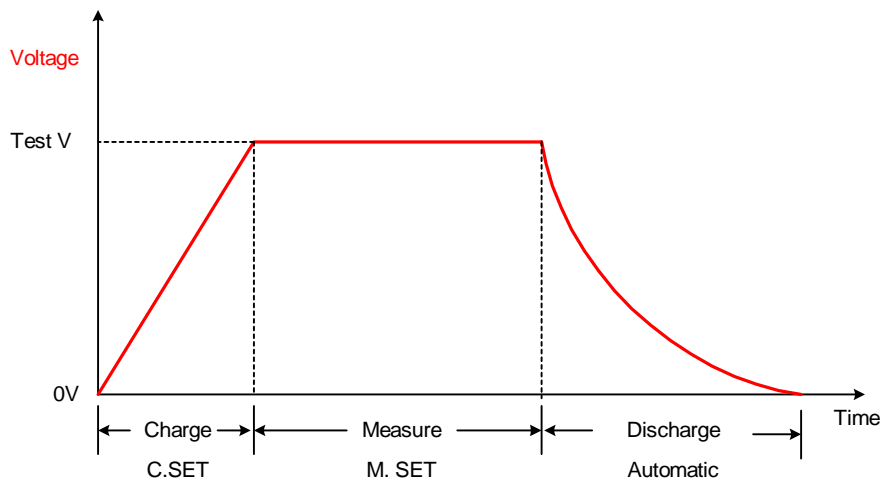

Figure 2-5: Measurement Cycle

2.5.2 M.SET

Measure time allows the device under test to stabilize at the programmed test voltage. Measure time can be set from 1 to 999 seconds. To set a MEASURE TIME to be applied to the DUT, press the [SELECT] button and make sure the test function **M.SET** is in the backlit box in the lower left-hand corner. Press the [UP] button to increase measure time or the [DOWN] button to decrease the measure time. Press [SELECT] again to exit and return to the measure display.

If a Measure Time is set, when [MEASURE] is pressed, the **V. OUT** LED lights and the 1860 instrument applies the test voltage to the test terminals for the programmed measure time. At the end of the measure time, the DUT is measured and the value is shown on the 1860 display.

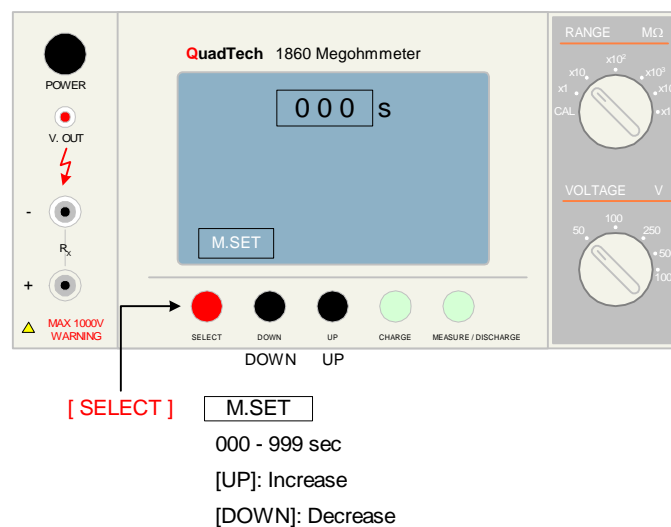

Figure 2-6: M. SET

2.5.3 COMP

The COMP function allows the user to set a GO/NO GO (Pass/Fail) limit for the device under test. The measured value will be compared against the comparison value ($\text{NO} < \text{COMP} \leq \text{GO}$) and both the measured value and the GO or NO result will be displayed.

The COMP value is set within a range and can be the minimum value of the range up to 10 times the value. **Note:** the COMP value is the Low Limit, the lowest value for a test to be judged a PASS (GO).

To set a Comparison value to be applied to the DUT, press the [SELECT] button and make sure the test function **COMP** is in the backlit box in the lower left-hand corner. Press the [UP] button to increase the COMP value or the [DOWN] button to decrease the COMP value. Press [SELECT] again to exit and return to the measure display.

NOTE:

The COMP value is only effective for the current Test Voltage and Range. If the Voltage or Range are changed then the COMP value becomes invalid. Set the Test Voltage and Range before setting any of the SELECT functions.

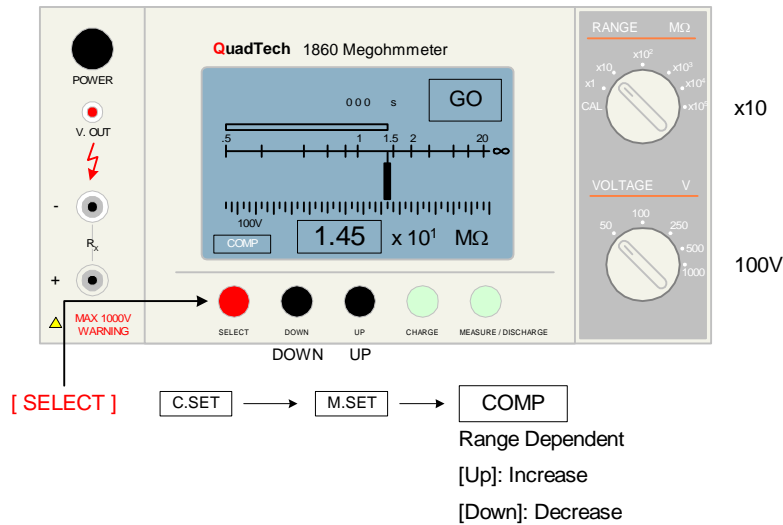

Figure 2-7: COMP

2.5.4 BUZZ

The 1860 is equipped with an audible warning indicator that will sound when the resultant COMP judgement is a NO (Fail). The BUZZ function allows the user to turn the buzzer ON or OFF. To change the BUZZ function, press the [SELECT] button and make sure the test function **BUZZ** is in the backlit box in the lower left-hand corner. Press the [UP] button to turn the buzzer OFF or the [DOWN] button to turn the buzzer ON. Press [SELECT] again to exit and return to the measure display.

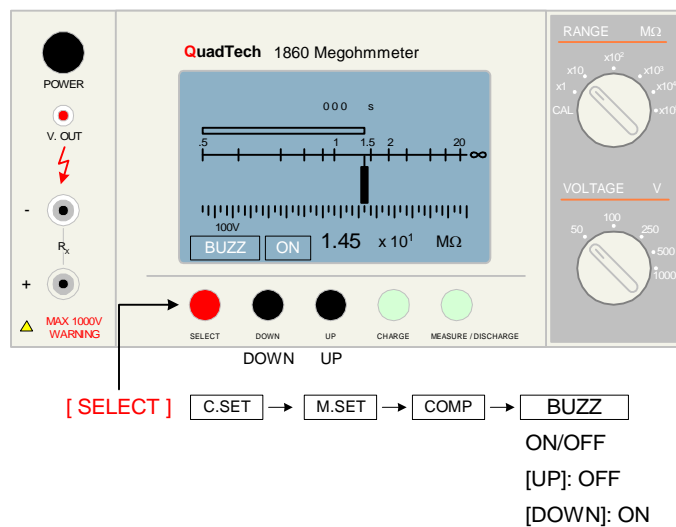

Figure 2-9: BUZZ

2.6 Discharge

The 1860 instrument is equipped with an automatic discharge function to drain any residual voltage left on the device under test after a measurement is made. The internal discharge circuit drains the residual voltage across a 100k Ω resistor. Discharge time is not user-programmable. At the end of the measurement, the DUT is automatically discharged when the [MEASURE/DISCHARGE] button is pressed.

The Discharge function is automatically performed each time the 1860 instrument is powered up and after each measurement.

Charge, Discharge and Dielectric Absorption

When voltage is applied to an insulator a large amount of current is produced. Dielectric absorption is the appearance of insulation absorbing an electrical charge slowly over time. Refer to the insulator equivalent circuit in Figure 2-9. As the voltage is applied to this circuit, a charge current flows through the bank of capacitors ($C_0, C_1, C_2, C_3, \dots, C_n$) until the current through R_0 is relatively constant. R_0 is the resistor to be measured. The series resistance associated with C_0, C_1, C_2, C_3 and C_n make a precise measurement of R_0 tricky as the charge is allowed to build up over an extended period of time.

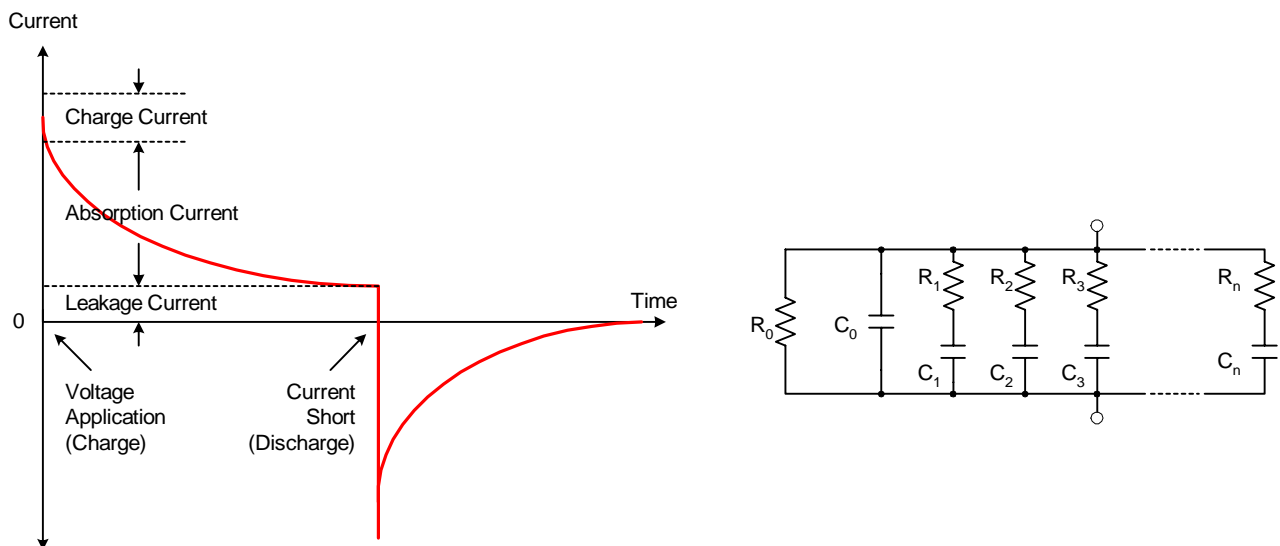

Figure 2-9: Current through an Insulator

To avoid waiting a long time for the leakage current to stabilize, many standards call out the 1-minute test method. The DUT is charged with the test voltage for 1 minute and then the insulation resistance reading is taken. To minimize deviation between measurements of the DUT, completely discharge the DUT after each measurement. The required discharge time depends on the voltage charge time. A general rule-of-thumb is discharge time is 5 to 6 times longer than charge time.

2.7 Connection to Device Under Test

WARNING

NEVER touch the test leads or the device under test when they are connected to the instrument and the red **V.OUT** light is ON or flashing.

Connect the 1860-01 test cables to the front panel Rx+ and Rx- connectors. Connect Black ground cable to Rx+ terminal. Connect Red high voltage cable to Rx- terminal. Make sure the test cables are fully inserted into the Rx+ and Rx- terminals to engage the safety plug insertion detector switch.

Refer to the Figures 2-10 through 2-11 to determine the correct configuration.

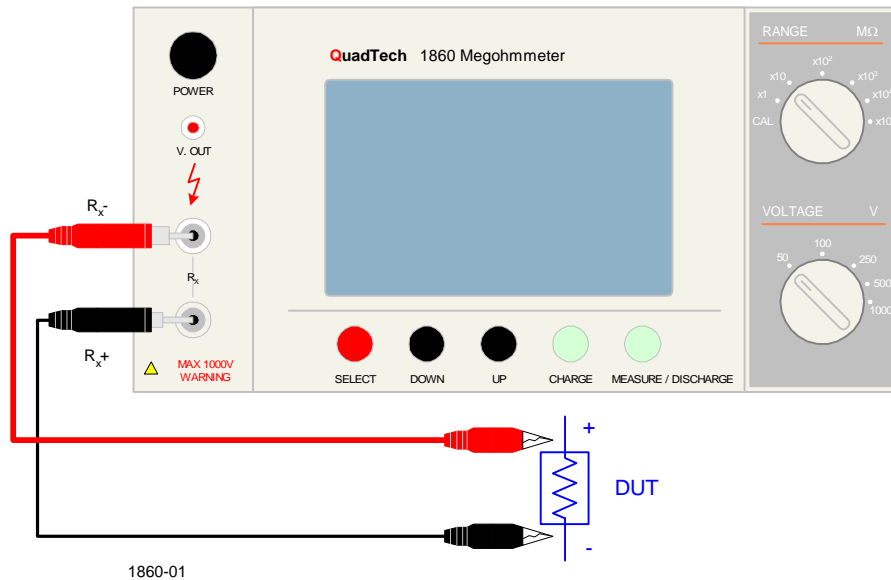

Figure 2-10: 1860-01 Connection to DUT

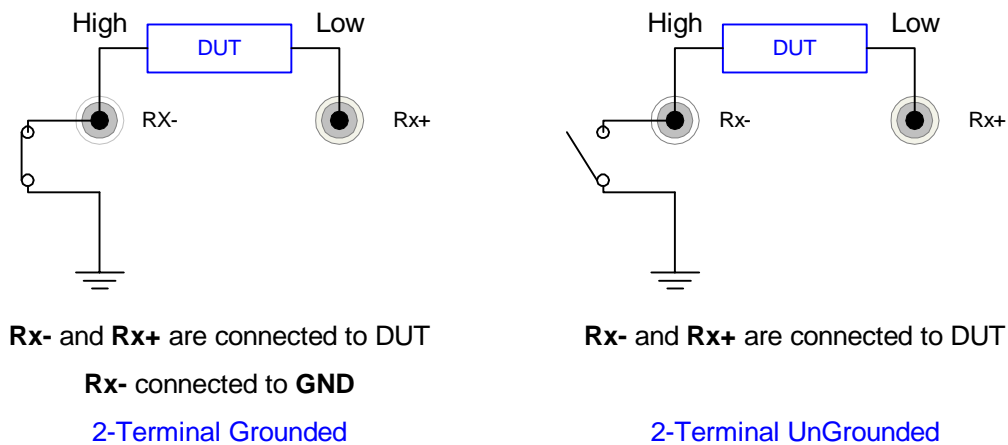
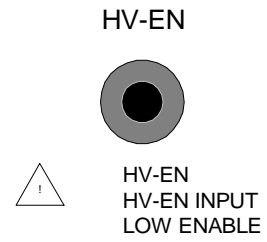
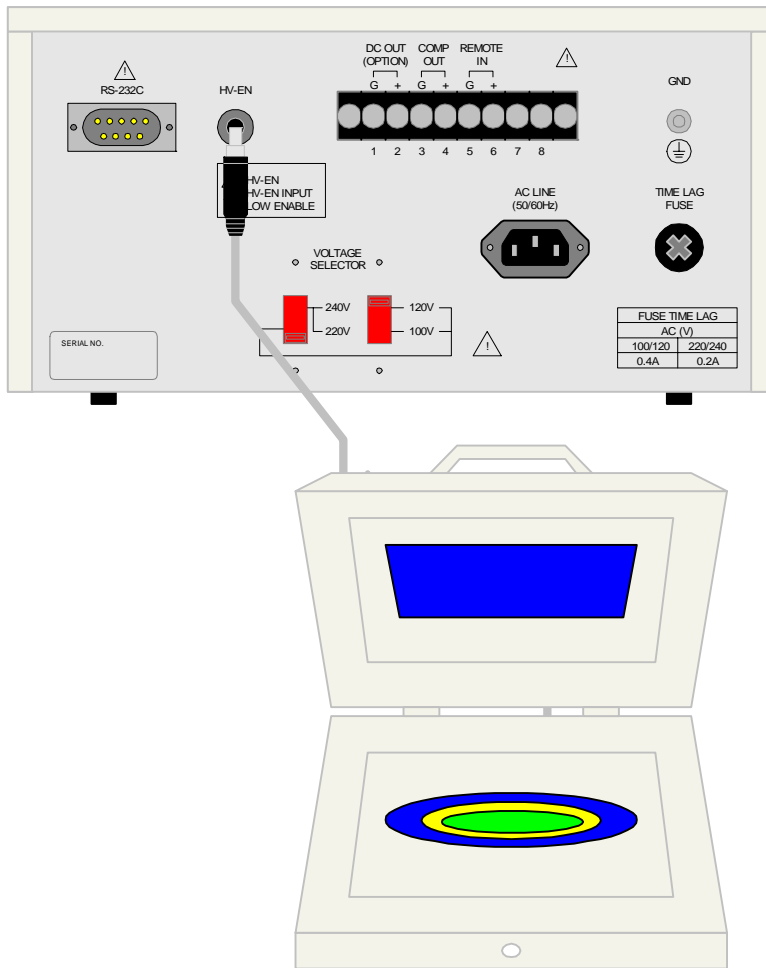

Figure 2-10a: 2-Wire Connection to DUT

Connection to DUT via 1860-02 Test Fixture:



1860-02: Surface Plate Sample Test Fixture

Max Sample Thickness: 8mm

Max Sample Size: 100mm x 100mm

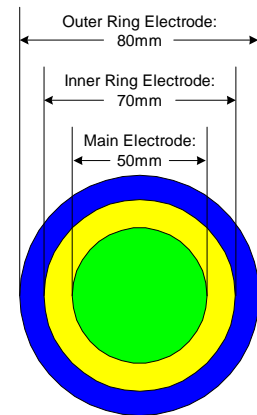

Figure 2-11: 1860-02 Surface Plate Sample Test Fixture

Refer to Section 3.4 and 3.5 for information on HV EN and the Surface Plate Sample Test Fixture (1860-02).

2.8 Measurement Procedure

Before a measurement is made, verify the following:

- 1 1860 instrument power is ON and 30 minute warm-up allowed
- 2 Turn [VOLTAGE] knob to test voltage
- 3 Turn [RANGE] knob to lowest multiplier
- 4 Press [SELECT] and enter your Test Parameters
- 5 Device Under Test (DUT) connected
- 6 Press [CHARGE]: Red V.OUT LED is lit
- 7 Press [MEASURE/DISCHARGE]: Red V.OUT LED is lit
- 8 Automatic DUT Discharge is part of the [MEASURE] cycle. The red V.OUT LED will shut OFF when the discharge function is complete.

NOTE:

At any time during the measurement, press the red [SELECT] button or [MEASURE/DISCHARGE] to terminate the High Voltage output at the test terminals.

2.9 Front Panel LOCK

When **LOCK** is displayed on the front panel, no lead is connected to the Rx+ and Rx- terminals or the interlock plug is not connected to the HV-EN terminal on the rear panel of the 1860 instrument. When **LOCK** is displayed, [CHARGE] and [MEASURE] buttons are non-functional.

Rx+ and Rx- Test Terminals:

- The Rx- test terminal contains a plug insertion detector switch. This safety detector switch assures that no high voltage can be output at the test terminals without the insertion of the proper test lead.

HV-EN Terminal:

- The rear panel HV-EN terminal is for high voltage output to an external test fixture. Voltage can be output at the rear HV-EN terminal or the front RX- terminal but not both simultaneously.

When connecting the DUT to an external test fixture via the rear panel HV-EN terminal, remove the interlock plug from the HV-EN terminal and connect the test fixture. The front panel Rx+ and Rx- terminals are then non-functional.

When using the 1860 instrument in normal configuration by connecting the DUT to the front panel Rx+ and Rx- connectors, the interlock plug must be inserted in the HV-EN connector on the rear panel. The HV-EN terminal is then non-functional.

Note: Refer to paragraph 3.3 for HV Enable Connection.

Section 3 : Interface

3.1 Remote

A remote terminal strip is located on the rear panel of the 1860 instrument. This black 10 screw relay strip has the remote output signals: COMP & DC OUT and an input connection: REMOTE IN.

The terminals are open collector as illustrated in Figure 3-1. Contact closure is required by the inputs and provided by the outputs.

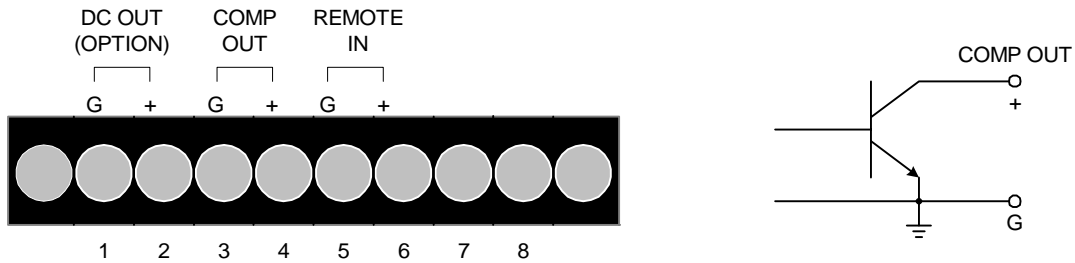

Figure 3-1: Remote Control Connector

3.1.1 COMP OUT

Figure 3-2 illustrates a possible remote control connection. Use extreme care when using the remote control connection as the High Voltage Output is being turned ON and OFF with with an external signal.

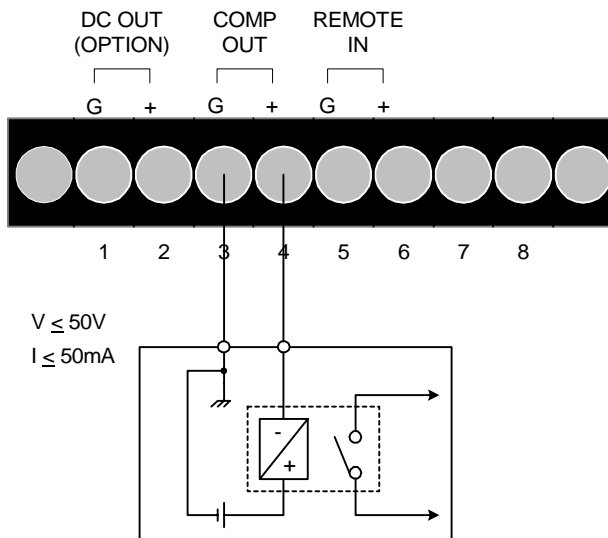

Figure 3-2: Single Control of COMP OUT

3.1.2 REMOTE IN Operation

To operate the 1860 remotely, connect a switch between the REMOTE IN “G” and “+” terminals on the rear panel terminal block. When the switch is closed the measurement cycle starts and when opened, the measurement ends. Figure 3-3 illustrates the Remote In connection. The 1860 instrument can be remotely controlled using the [REMOTE IN] connection and the timing diagram.

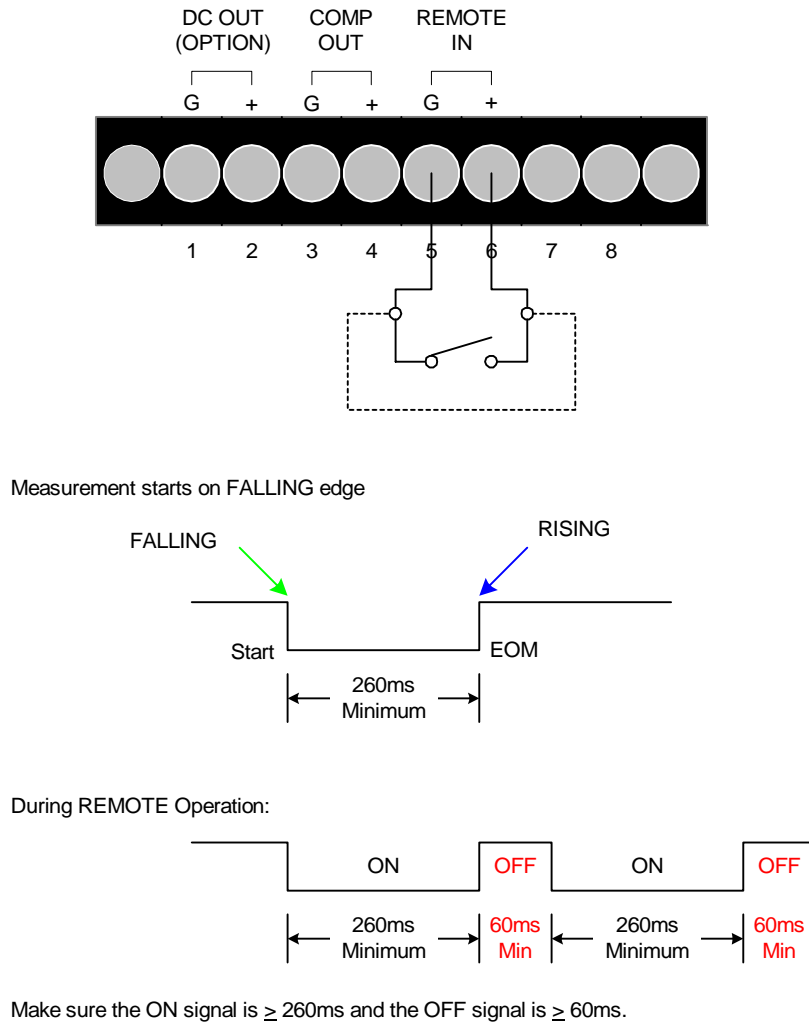

Figure 3-3: Remote In Connection

For proper operation of the REMOTE IN circuit, make sure the ON signal is ≥ 260 milliseconds and the OFF signal is ≥ 60 milliseconds. If the signal is less than the limit, the signal may not be received.

Notes on REMOTE IN Operation:

1. Setting Measuring Time:

When a measuring time is set using the 1860 timer, the timer has priority over the remotely controlled switch actuation.

When the REMOTE IN “G” and “+” terminals are closed, the measurement will start. The measurement will automatically end when the time set with the timer is up.

If the “G” and “+” terminals are opened before the timer is up, the opening of the “G” and “+” terminals takes priority over the timer.

2. Setting Charge Time:

When a charge time is set using the 1860 timer, the timer has priority over the remotely controlled switch actuation.

When the REMOTE IN “G” and “+” terminals are closed, the charge time will start. The measurement will automatically start when the time set with the timer is up.

If the “G” and “+” terminals are opened before the timer is up, the opening of the “G” and “+” terminals takes priority over the timer.

3. Setting Charge and Measuring Time:

When both charge and measure times are set using the 1860 timer, the timer has priority over the remotely controlled switch actuation.

When the REMOTE IN “G” and “+” terminals are closed, the charge time will start. The measurement will automatically start when the charge time set with the timer is up. The measurement will automatically end when the measure time set with the timer is up.

If the “G” and “+” terminals are opened before the timer is up (either during charge or measure), the opening of the “G” and “+” terminals takes priority over the timer.

3.1.3 DC OUT

Optional DC Signal output is available on the 1860 instrument. The DC signal can be output in two methods: as linearly proportional to the measured resistance or as inversely proportional (1/R) to the measured resistance. To use the DC OUT option, connect a switch between the DC OUT “G” and “+” terminals on the rear panel terminal block. When the switch is closed the DC signal is output and when opened, the DC signal is shut off. Figure 3-4 illustrates the DC OUT connection.

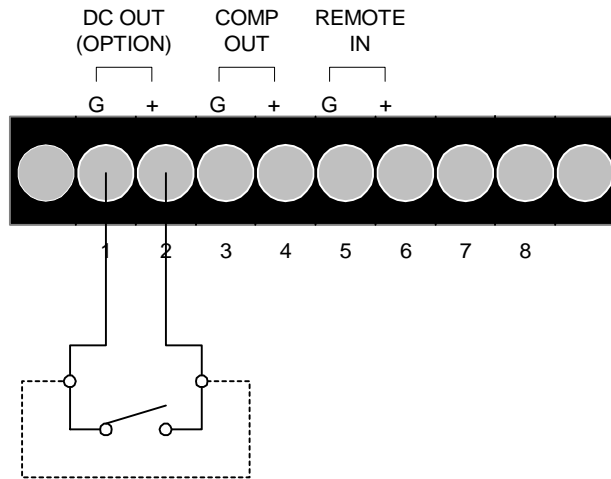

Figure 3-4: DC OUT Option

When the DC Signal is output linearly ($R=V/I$), if the voltage remains constant and the resistance is doubled then the current is cut in half. The specifications for the 1860 instrument when using the DC Out option are listed in Table 3-1.

Table 3-1: DC Out Specifications

Spec	Linear Output (R)	Inverse Output (1/R)
Output Range	Full Scale to 10x FS	Full Scale
Output Voltage	1V at FS; 10V at 10x FS	10V at FS; 1V at 10x FS
Accuracy	$\pm 10\%$ FS	$\pm 10\%$ FS to $\pm 10\%$ (10x FS)

3.2 RS232 Interface

3.2.1 PIN Configuration

The 1860 Megohmmeter is equipped with an RS-232C interface for remote operation of the instrument. The black DB9-pin male RS-232C connector is located on the rear panel of the 1860 instrument. Figure 3-5 illustrates the RS232 PIN configuration.

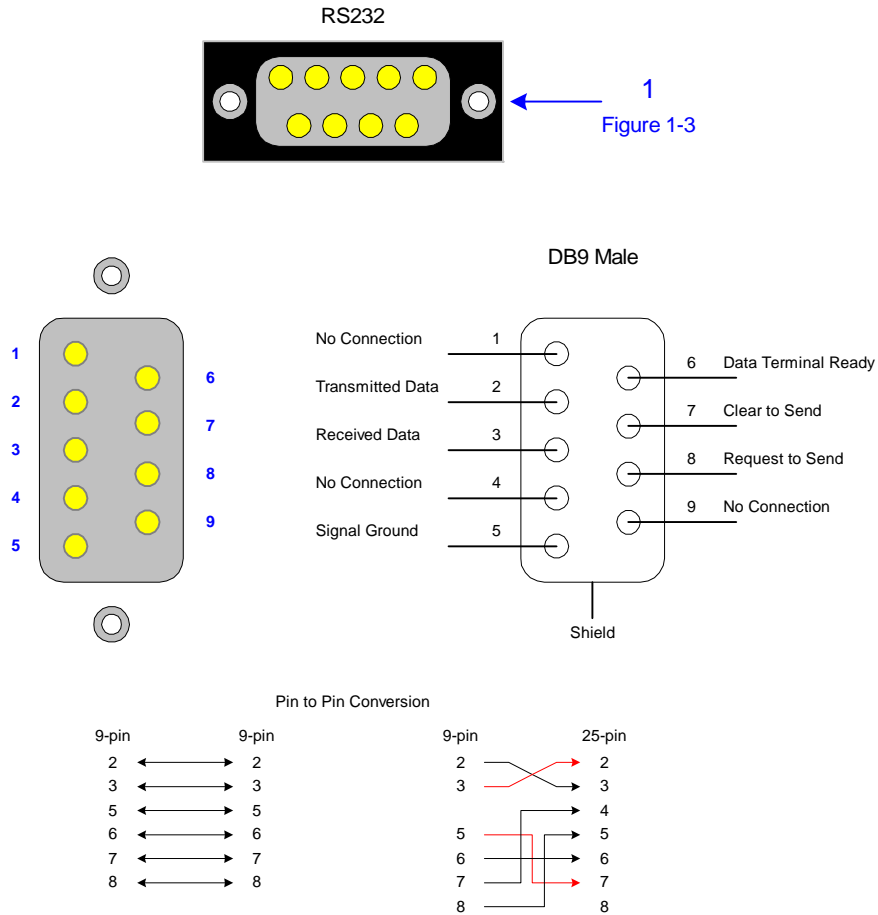

Figure 3-5: RS232 PIN Configuration

3.2.2 RS232 Specifications

Data bits: 8
 Stop bits: 1
 Parity: None
 Baud Rate: 9600
 EOS: CR + LF
 Flow Control: RTS/CTS

3.2.3 RS232 Commands

The command set for the RS232 interface is listed in Table 3-2.

NOTE: CR + LF is the end code for the RS232 Commands.

Table 3-2: RS-232 Commands

Mnemonic	Contents	Format	Response	Example
R	Set Measure Data	R [CR] [LF]	****E* 0 or 1 Judgment: [GO] 1, [NO] 0	10.0E4, 0 [CR] [LF]
M	Start Measurement	M [CR] [LF]	0 (valid) or 1 (invalid)	
C	Start Charge	C [CR] [LF]	0 (valid) or 1 (invalid)	
S	Stop Measurement	S [CR] [LF]	0 (valid) or 1 (invalid)	
T	Set Measure Time	T*** (000-999) [CR] [LF]	0 (valid) or 1 (invalid)	T 60 [CR] [LF]
G	Set Charge Time	G*** (000-999) [CR] [LF]	0 (valid) or 1 (invalid)	G 120 [CR] [LF]
P	Set COMP value	P*** (000-999) [CR] [LF]	0 (valid) or 1 (invalid)	P 100 [CR] [LF]
B	Set Buzzer	B [OFF] 0 or [ON] 1[CR] [LF]	0 (valid) or status	B 1
U	Set Measure Output	U [CR] [LF]	Range, Voltage, Interlock or Status	4, 1000, 0, 2 [CR] [LF]
I	Instrument I.D.	I [CR] [LF]	Model, Version	1860 V1.00 [CR] [LF]

Measure Output (U):

Range: 0 – 8, resistance

Voltage: 5 – 1000 V

Interlock: 0 (OFF), 1 (ON)

Status: Standby – 2

Under Test – 3

Charging – 4

On – 5

Calibrating – 6

Timer ON – 7

For the [R] command, a state only response will be received. During measurement when the timer is functioning a state 7 only response will be received.

When Charge Time is set upon receipt of the [C] command, a measurement will start as soon as the charge time is complete.

For the [P] command, if a value outside of the specified measuring range is measured, then an invalid (1) response will be sent.

3.2.4 RS232 Printer Output

Measured data can be output to an optional printer via the RS232 interface on the rear panel of the 1860 Megohmmeter. Use a straight through RS-232 cable to connect to the printer. The 9-pin to 9-pin and 9-pin to 25-pin configurations are shown in Figure 3-5. Set the measure parameters (paragraphs 2.3-2.5), connect the DUT and press [MEASURE]. When the measurement is complete, the data will be output to the printer. Example: if the measurement result is $10.0 \times 10^4 \text{ M}\Omega$ and a GO judgement, then the printer will output: 10.0E4, 0.

3.3 HV EN (High Voltage Enable)

On the rear panel of the 1860 Megohmmeter is a silver banana jack connector labeled HV EN as illustrated in Figure 3-6. The rear panel HV-EN terminal is for high voltage output to an external test fixture. Voltage can be output at the rear HV-EN terminal or the front RX- terminal but not both simultaneously.

When connecting the DUT to an external test fixture via the rear panel HV-EN terminal, remove the interlock plug from the HV-EN terminal and connect the test fixture as illustrated in Figure 3-6. The front panel Rx+ and Rx- terminals are then non-functional.

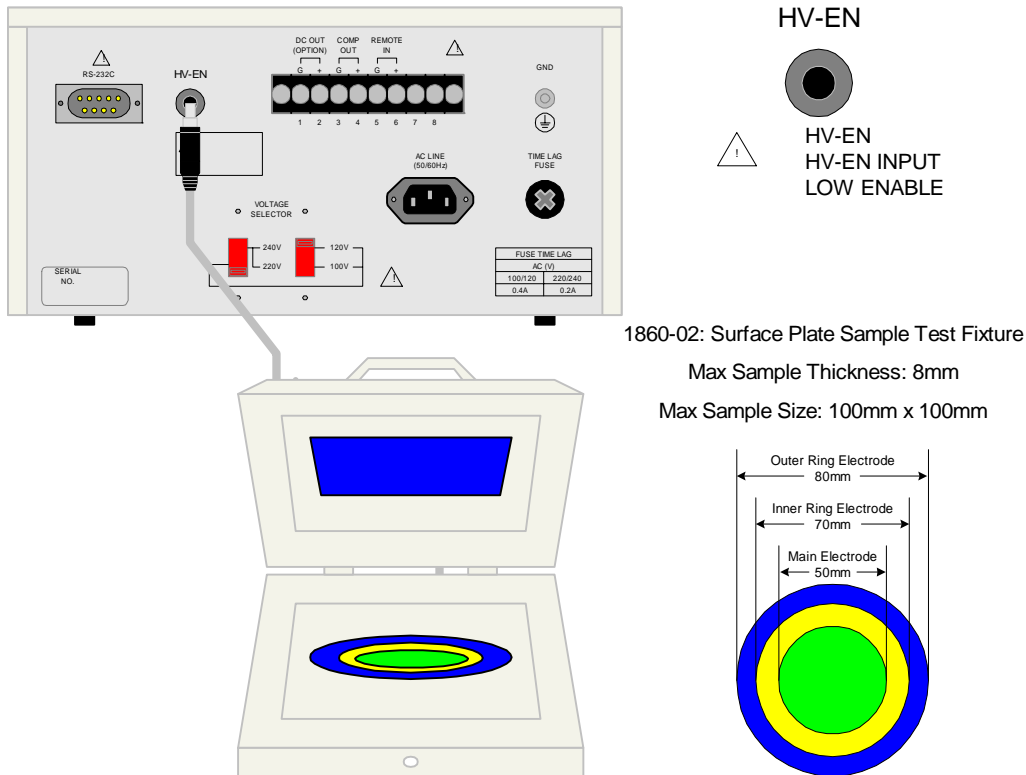

Figure 3-6: HV EN Connection to 1860-02 Surface Plate Sample Test Fixture

3.4 Surface Plate Sample Test Fixture

The 1860-02 Surface Plate Sample Test Fixture is an optional accessory for the 1860 Megohmmeter. The 1860-02 fixture can be used for both surface and volume resistivity measurements on a sample. The maximum sample size is 100mm x 100mm and the maximum sample thickness is 8mm. Figure 3-7 illustrates the 1860-02 Test Fixture and Figure 3-8 details the calculations for surface and volume resistivity.

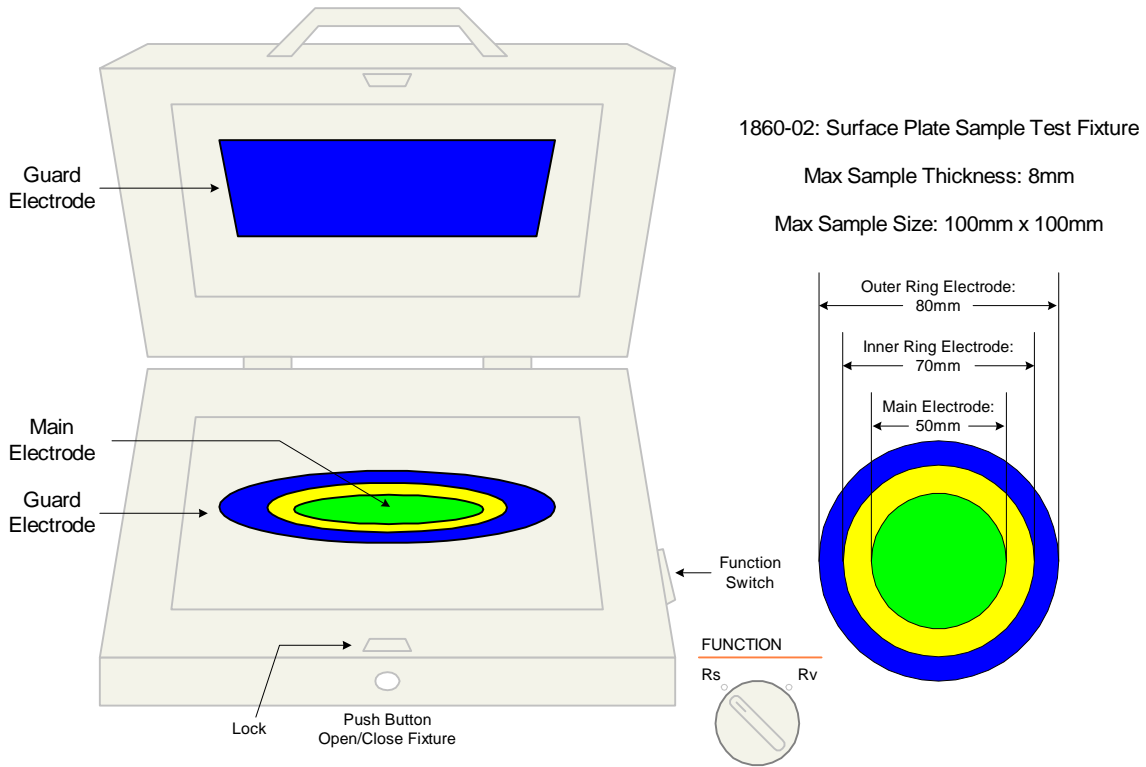
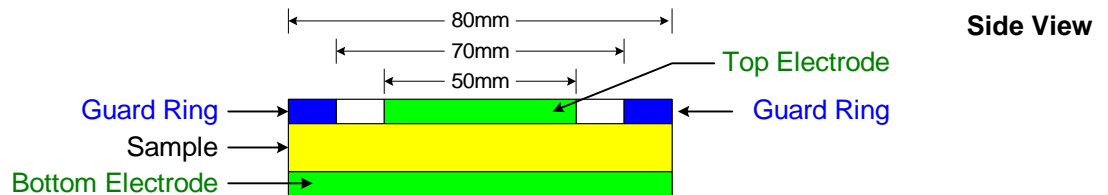

Figure 3-7: 1860-02 Test Fixture



R1 = Main Electrode Diameter = 5cm

R2 = Inner Guard Electrode Diameter = 7cm

t = Sample Thickness in cm

Rs = Measured Surface Resistance in Ω

Rv = Measured Volume Resistance in Ω

$$\text{Volume Resistivity: } \rho = \left[\frac{\pi (R1)^2}{4t} \right] Rv \quad \Omega\text{-cm}$$

$$\text{Surface Resistivity: } \sigma = \left[\frac{\pi (R1 + R2)}{(R2 - R1)} \right] Rs \quad \Omega$$

Figure 3-8: Surface & Volume Resistivity

Section 4 : Service & Calibration

4.1 General

Our warranty (at the front of the manual) attests to the quality of materials and workmanship in our products. If malfunction should be suspected, or other information be desired applications engineers are available for technical assistance. Application assistance is available in the U.S. by calling 978-461-2100 and asking for Applications Support. For support outside of the United States please contact your local QuadTech distributor.

4.2 Instrument Return

Before returning an instrument to QuadTech for service please call our **Customer Care Center (CCC)** at **800-253-1230** for Return Material Authorization (RMA). It will be necessary to include a Purchase Order Number to insure expedient processing, although units found to be in warranty will be repaired at no-charge. For any questions on repair costs or shipment instructions please contact our CCC Department at the above number. To safeguard an instrument during storage and shipping please use packaging that is adequate to protect it from damage, i.e., equivalent to the original packaging and mark the box "Delicate Electronic Instrument". Return material should be sent freight prepaid, to:

QuadTech, Inc.
5 Clock Tower Place, 210 East
Maynard, MA 01754

Attention: RMA #

Shipments sent collect cannot be accepted.

4.3 Calibration

Verification of the 1860 instrument is recommended on an annual basis. If the 1860 unit is returned to QuadTech for factory calibration refer to paragraph 4.2 for instructions. Calibration should be carried out by a qualified service person with traceable calibration equipment and standards. **The instrument should be powered up for a minimum of 1 hour before calibration to ensure maximum stability.**